

XO24

SPEAKER MANAGEMENT CONTROLLER



Users manual

IMPORTANT SAFETY INSTRUCTIONS



The lightning flash with an arrowhead symbol within an equilateral triangle, is intended to alert the user to the presence of uninsulated "dangerous voltage" within the product's enclosure that may be of sufficient magnitude to constitute a risk of electric shock to persons.



The exclamation point within an equilateral triangle is intended to alert the user to the presence of important operating and maintenance (servicing) instructions in the literature accompanying the product.

- 1 Read these instructions.
- 2 Keep these instructions.
- 3 Heed all warnings.
- 4 Follow all instructions.
- 5 Do not use this apparatus near water.
- 6 Clean only with dry cloth.
- 7 Do not block any ventilation openings. Install in accordance with the manufacturer's instructions.
- 8 Do not install near any heat sources such as radiators, heat registers, stoves, or other apparatus (including amplifiers) that produce heat.
- 9 Do not defeat the safety purpose of the polarized or grounding-type plug. A polarized plug has two blades with one wider than the other. A grounding type plug has two blades and a third grounding prong. The wide blade or the third prong are provided for your safety. If the provided plug does not fit into your outlet, consult an electrician for replacement of the obsolete outlet.
- 10 Protect the power cord from being walked on or pinched particularly at plugs, convenience receptacles, and the point where they exit from the apparatus.
- 11 Only use attachments/accessories specified by the manufacturer.
- 12  Use only with the cart, stand, tripod, bracket, or table specified by the manufacturer, or sold with the apparatus. When a cart is used, use caution when moving the cart/apparatus combination to avoid injury from tip-over.
- 13 Unplug this apparatus during lightning storms or when unused for long periods of time.
- 14 Refer all servicing to qualified service personnel. Servicing is required when the apparatus has been damaged in any way, such as power-supply cord or plug is damaged, liquid has been spilled or objects have fallen into the apparatus, the apparatus has been exposed to rain or moisture, does not operate normally, or has been dropped.

Warning!

- To reduce the risk of fire or electrical shock, do not expose this equipment to dripping or splashing and ensure that no objects filled with liquids, such as vases, are placed on the equipment.
- This apparatus must be earthed.
- Use a three wire grounding type line cord like the one supplied with the product.
- Be advised that different operating voltages require the use of different types of line cord and attachment plugs.
- Check the voltage in your area and use the correct type. See table below:

Voltage	Line plug according to standard
110-125V	UL817 and CSA C22.2 no 42.
220-230V	CEE 7 page VII, SR section 107-2-D1/IEC 83 page C4.
240V	BS 1363 of 1984. Specification for 13A fused plugs and switched and unswitched socket outlets.

- This equipment should be installed near the socket outlet and disconnection of the device should be easily accessible.
- To completely disconnect from AC mains, disconnect the power supply cord from the AC receptable.
- The mains plug of the power supply shall remain readily operable.
- Do not install in a confined space.
- Do not open the unit - risk of electric shock inside.

Caution:

You are cautioned that any change or modifications not expressly approved in this manual could void your authority to operate this equipment.

Service

- There are no user-serviceable parts inside.
- All service must be performed by qualified personnel.

IMPORTANT SAFETY INSTRUCTIONS

EMC / EMI.

This equipment has been tested and found to comply with the limits for a Class B Digital device, pursuant to part 15 of the FCC rules. These limits are designed to provide reasonable protection against harmful interference in residential installations. This equipment generates, uses and can radiate radio frequency energy and, if not installed and used in accordance with the instructions, may cause harmful interference to radio communications. However, there is no guarantee that interference will not occur in a particular installation. If this equipment does cause harmful interference to radio or television reception, which can be determined by turning the equipment off and on, the user is encouraged to try to correct the interference by one or more of the following measures:

- Reorient or relocate the receiving antenna.
- Increase the separation between the equipment and receiver.
- Connect the equipment into an outlet on a circuit different from that to which the receiver is connected.
- Consult the dealer or an experienced radio/TV technician for help.

For the customers in Canada:

This Class B digital apparatus complies with Canadian ICES-003.

Cet appareil numérique de la classe B est conforme à la norme NMB-003 du Canada.

Certificate Of Conformity

TC Electronic A/S, Sindalsvej 34, 8240 Risskov, Denmark, - hereby declares on own responsibility that following products:

XO24 - Loudspeaker Management Controller

- that is covered by this certificate and marked with CE-label conforms with following standards:

EN 60065 (IEC 60065)	Safety requirements for mains operated electronic and related apparatus for household and similar general use
EN 55103-1	Product family standard for audio, video, audio-visual and entertainment lighting control apparatus for professional use. Part 1: Emission.
EN 55103-2	Product family standard for audio, video, audio-visual and entertainment lighting control apparatus for professional use. Part 2: Immunity.

With reference to regulations in following directives:

73/23/EEC, 89/336/EEC

January 2005
Mads Peter Lübeck
Chief Executive Officer

TABLE OF CONTENTS

INTRODUCTION

<i>Important Safety Instructions & Certificate of conformity</i>	a-b
<i>Table of Contents</i>	3
<i>Introduction</i>	4
<i>Front Panel Overview</i>	6
<i>Rear Panel Overview</i>	8
<i>Signal Flow Diagram</i>	9
<i>Typical Setups</i>	10

OPERATION

<i>Control Section</i>	15
<i>Editing Parameters</i>	15
<i>Recall</i>	15
<i>Store</i>	15
<i>The Setup Menu</i>	15
<i>The Lock mode</i>	15
<i>Front Panel Operation</i>	16

APPENDIX

<i>Technical Specifications</i>	19
<i>Preset List</i>	20

INTRODUCTION

Congratulations on the purchase of your new XO24 Speaker Management Controller. We are confident that you will find this controller to be the best product of its kind in this price range.

The XO24 is an easy-to-use, high quality digital X-over unit, that allows easy configuration of speaker systems. This applies for basically all types of speaker management in live-sound production. The Speaker Management Controller XO24 is a compact and powerful DSP based "2-In/4Out" audio-processing unit, ideally suited for both fixed installations and in live applications, combining functions of multiple conventional products in a compact 1U rack space.

The XO24 controller is built to provide extremely high quality frequency division and uses the well known TC quality components and technologies. The XO24 covers not only all the traditional X-over functions, but also features as:

- Input EQ for Room and Placement Compensation (4 band parametric pr. Input Ch.)
- Unique Routing Engine (Any Input to Any Output)
- 2, 3 & 4-way X-Over on all Outputs (Butterworth, Bessel and Linkw. Riley type filters available)
- Speaker Voicing EQ, (4 band parametric pr. Output Ch.)
- Independent Speaker Alignment Delay on all outputs (200 ms pr. Ch.)
- Independent Digital Limiter on all Outputs
- Intuitive Signal Flow Based User Interface
- Factory presets
- 100 User Preset location

The XO24 digital system controller has two balanced XLR analog inputs, a digital Input at 44.1 or 48kHz, and four balanced XLR analogue Outputs.

This manual

Read through this operation manual to get more information about the specific features available in XO24, or start to use the XO24 right out of the box and get back to these pages in case you seek answers to specific features.

For any questions left unanswered by this manual feel free to visit our online support center; TC Support Interactive, which can be accessed via: www.tcelectronic.com

Latest manual revision can always be downloaded from www.tcelectronic.com

FRONT PANEL OVERVIEW

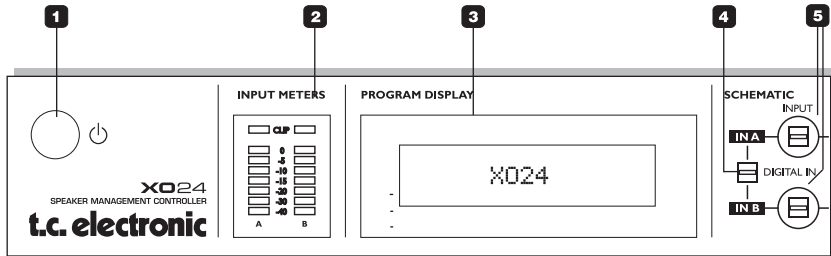

1 POWER On/Off

The XO24 uses a switchmode power-supply that accepts from 100-240V AC.

2 INPUT METERS

For optimal performance the Input level indication should be around -5dB and occasionally peak at 0dB.

If the CLIP indicator is lit the Input signal is too hot.

Input sensitivity can be set in the Level menus accessed via the INPUT A/B keys, or via the Setup menu.

3 DISPLAY

32 character LCD displaying various operating parameters.

4 DIGITAL IN select

Press the DIGITAL IN key and the XO24 will try to lock to the Digital Input. If a valid digital clock is present on the Input the unit will automatically use the digital signal as Input source.

Press once more to release and switch to analog Inputs.

5 INPUT A/B

On/Off switches for the two channels. For the signal to pass further down the signal chain the key LEDs must be lit.

In Edit mode these switches give access to the Input Trim parameter for each channel.

6 PAR EQ A/B

On/Off switches for the Parametric EQ on channel A and B.

In Edit mode these keys give access to edit EQ settings.

7 ROUTING matrix

The Output Routing Matrix allows you to freely distribute Input channels A/B to any of the four Output channels.

Use the four switches in column A to send the signal from Input channel A to any of the four Outputs.

Use the four switches in column B to send the signal from Input channel B to any of the four Outputs.

8 X-OVER keys

On/Off switches for the X-Overs.

In Edit mode these keys give access to edit X-Over settings.

9 EQ

On/Off switches for the EQ section on the four Output channels.

In Edit mode these keys give access to edit the EQ parameters.

10 DELAY LINE

On/Off keys for the Delay block on the four Output channels.

In Edit mode these keys give access to edit the Delay parameters.

11 LIMITER

On/Off keys for the Limiter block on the four Output channels.

In Edit mode these keys give access to edit the Limiter parameters.

FRONT PANEL OVERVIEW

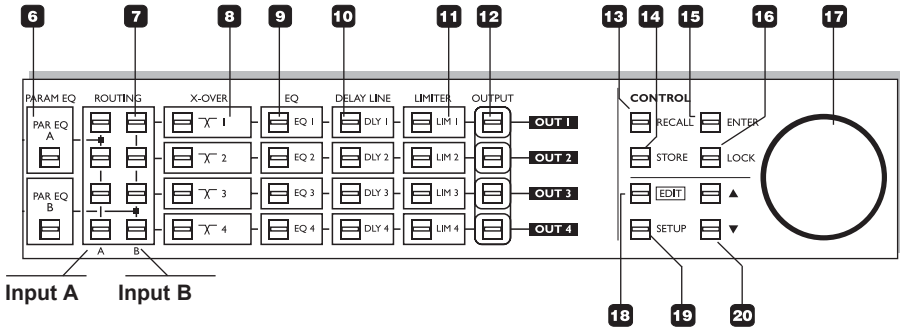

12 OUTPUT

On/Off keys on the Output for each of the four channels.

In Edit mode these keys give access to edit the Output level parameter.

13 RECALL

In Recall mode you select which preset to recall using the ADJUST encoder and press ENTER to confirm.

14 STORE

Press to STORE. Select a storing location using the ADJUST wheel and press ENTER to confirm.

15 ENTER

The ENTER key is used to confirm various operations such as Store and Recall.

16 LOCK

The LOCK key is used to lock/unlock the XO2 front panel keys. Default setting is "locked".

17 ADJUST encoder

The ADJUST Encoder is used to change values on various parameters - especially in the Edit mode.

18 EDIT

Press to enter Edit mode and select which parameter to edit by pressing the parameter keys.

19 SETUP

Press to enter the Setup menu. In the Setup menu you will find parameters such as Lock setup, various Level settings and Display Viewing.

20 CURSOR keys

Use the CURSOR keys to scroll between parameters in the various menus.

REAR PANEL

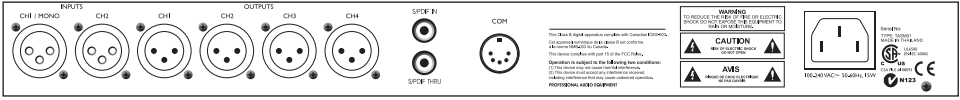

Balanced Inputs on XLR for channels A/B. Use channel A for mono Input.

Balanced Outputs 1-4 on XLR.

Digital S/PDIF In and Thru on RCA phono.

Com port for data transfer. NO user application.

Power Input. The internal switchmode powersupply accepts from 100 to 240 VAC.

SIGNAL FLOW

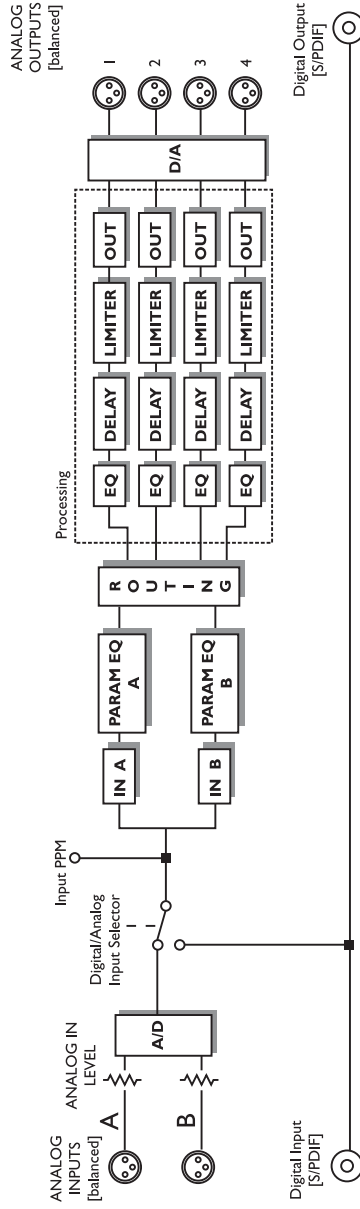

TYPICAL SETUPS

Stereo Setup - with subs

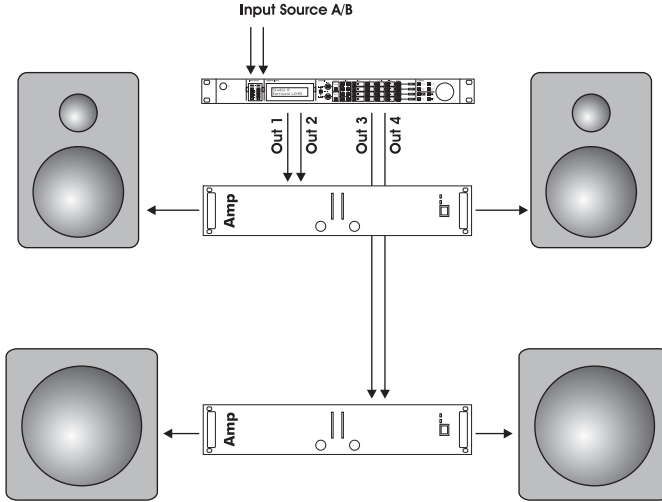

This is a typical stereo setup with a set of subs.

Analog:

- Input signal is fed on Inputs A/B.
- Configure Routing section as illustrated below.
- Output channels 1 and 2 feed the front loudspeakers.
- Output channels 3 and 4 feed the subs.

Configuration overview

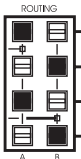

Using the Digital Input

- Digital Input 44.1 or 48kHz must be present in the Digital Input.
- Press and hold the DIGITAL IN button on the front panel until digital lock is achieved.

Note: The signal present on the DIGITAL INPUT is passed unprocessed to the DIGITAL THRU connection on the rear panel for further downstream processing.

TYPICAL SETUPS

Stereo Setup

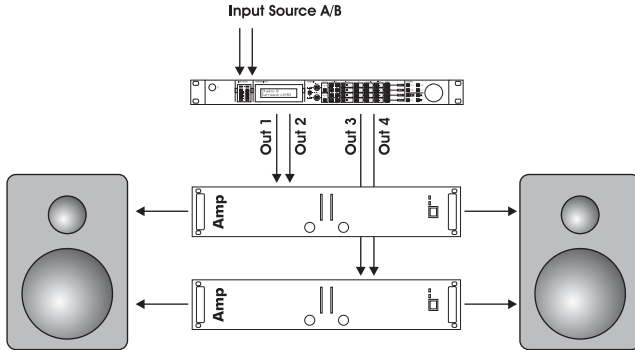

This setup is a typical small 2-way system.

Analog

- Input signal is fed to Inputs A and B.
- Configure Routing section as illustrated below.
- Output channels 1 and 2 feed loudspeaker set A.
- Output channels 3 and 4 feed loudspeaker set B.

Configuration overview

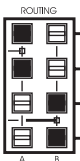

Using the Digital Input

- Digital Input 44.1 or 48kHz must be present in the Digital Input.
- Press and hold the DIGITAL IN button on the front panel until digital lock is achieved.

Note: The signal present on the DIGITAL INPUT is passed unprocessed to the DIGITAL THRU connection on the rear panel for further downstream processing.

SETUPS

3/4 way setup - Bi-Amp Mid/High

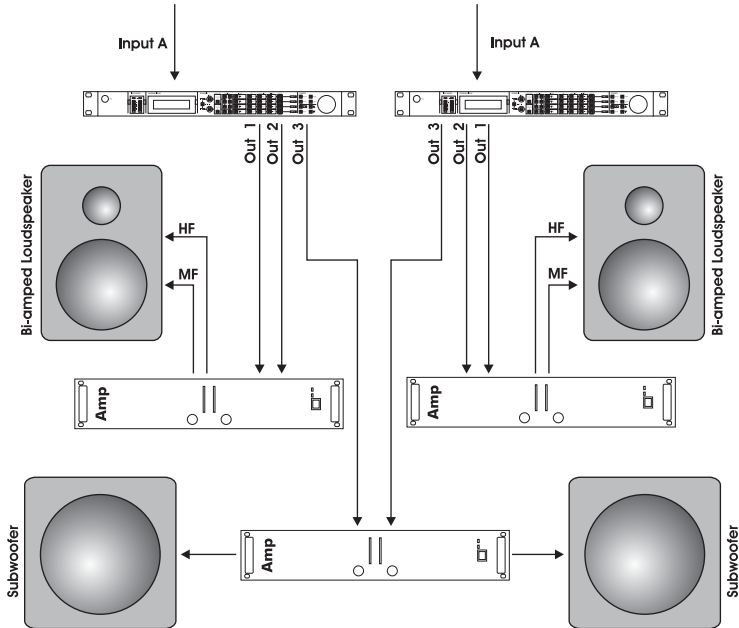

This example shows how 2 XO24s can be used in conjunction to distribute Input signals to a 3 or 4 way system per side.

For each side:

- Source signal can be connected to either Inputs A or B as only one Input per side is used. For this example - use Input A on both controllers.
- Configure the Routing section as illustrated below.
- Set Crossovers and additional parameters.

Configuration overview

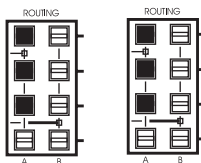

Using the Digital Input

- Digital Input 44.1 or 48kHz must be present in the Digital Input.
- Press and hold the DIGITAL IN button on the front panel until digital lock is achieved.

Note: The signal present on the DIGITAL INPUT is passed unprocessed to the DIGITAL THRU connection on the rear panel for further downstream processing.

SETUPS

System Distribution - with delay

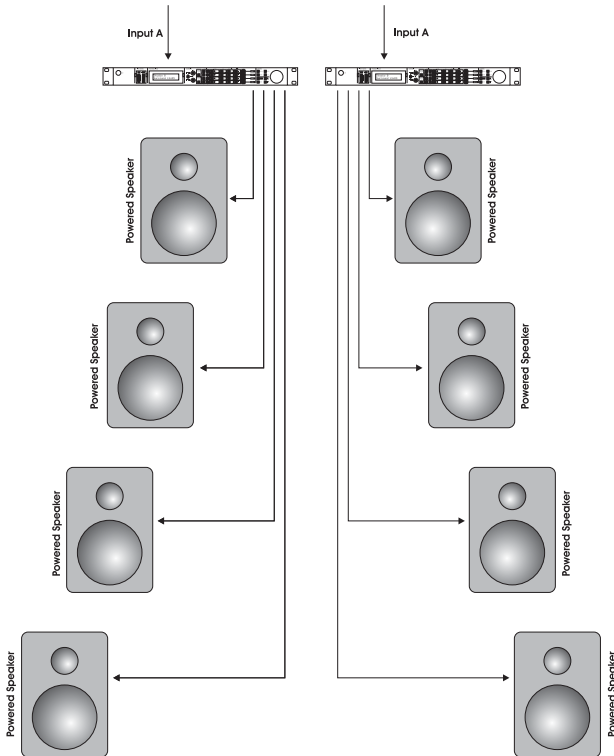

This example is similar to the previous example. However, the idea here is to distribute the signal with delay settings corresponding to the positioning of the speakers.

For each side:

- Source signal can be connected to either Inputs A or B as only one Input per side is used. For this example - use Input A on both controllers.
- Configure Routing section as illustrated in the configuration overview.
- Set a Delay time per channel matching the distance between the speakers.
- Set additional processing parameters.

Configuration overview

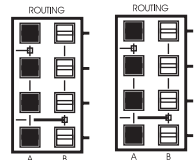

Using the Digital Input

- Digital Input 44.1 or 48kHz must be present in the Digital Input.
- Press and hold the DIGITAL IN button on the front panel until digital lock is achieved.

Note: The signal present on the DIGITAL INPUT is passed unprocessed to the DIGITAL THRU connection on the rear panel for further downstream processing.

SETUPS

Dual Source Mono - Dual Zone

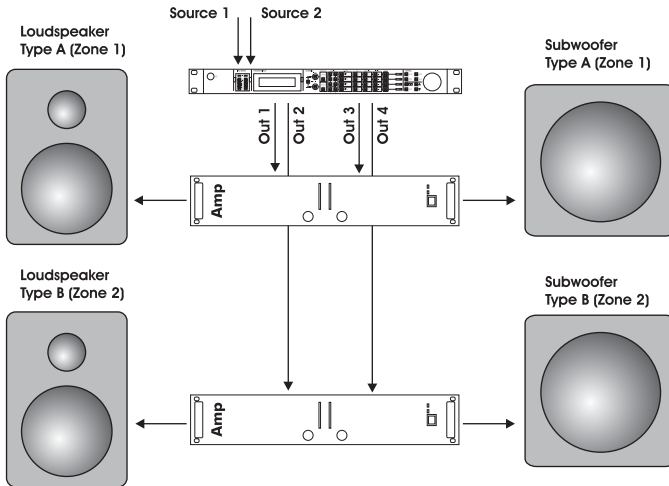

This setup is used where two different zones or rooms need to be covered. In this case Stereo is not the object.

- Source 1 is connected to Input A and Source 2 to Input B.
- Configure the Routing section as illustrated below.
- Set Crossovers and additional parameters.

Configuration overview

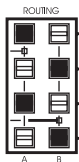

Using the Digital Input

- Digital Input 44.1 or 48kHz must be present in the Digital Input.
- Press and hold the DIGITAL IN button on the front panel until digital lock is achieved.

Note: The signal present on the DIGITAL INPUT is passed unprocessed to the DIGITAL THRU connection on the rear panel for further downstream processing.

CONTROL SECTION

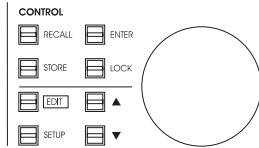

Editing Parameters

Parameters in the Edit mode:

- Press EDIT followed by the key corresponding to the block you wish to edit.
- Use the CURSOR keys to select parameter and the ADJUST encoder to set the desired value.

Notice that the Lock function may be engaged and you will in that case not be able to edit parameters until it is disengaged. Please see the next column to learn about the Lock function.

Recall

To recall a preset

- Press RECALL
- Select preset using the ADJUST encoder
- Press ENTER



Reduce volume before recalling presets. Recalling a new preset may cause radical changes to both gain and routing settings.

Store

100 locations are available for user presets.

To store a preset

- 1 Press STORE
- 2 If the currently recalled preset is a User preset the same user location is suggested.
 - If the currently recalled preset is a factory preset, the first free user location is suggested.
 - If you wish to store the preset at a different location - select the desired user location using the ADJUST encoder.
- 3 Press ENTER.

- 4 Now you may;
 - either press ENTER again to confirm and end the store operation
 - or dial in a preset name of your choice using the CURSOR keys and ADJUST encoder and *then* press ENTER.
- 5 The display indicates "Preset Stored" for a successful store operation.

The Setup menu

The Setup menu holds various overall setup parameters.

Output Range

Range: 2, 8 (consum), 14, 20(pro) dBu.
The Output range should match the Input sensitivity of your downstream device/amplifier. Please refer to the manual of that device.

Input Sensitivity

Range: 0 to 24dBu
The Input range should match the Output range of your feeding device. Please refer to the manual of that device or adjust according to the Input meters.

Delay Unit

The Delay time can be displayed in milliseconds, meters or feet.

Lock Function - introduction

As a speaker management controller is a key component in speaker setups a lock function is provided to prevent unintended change of parameters via the frontpanel.

Setting up the LOCK function is done via the Setup menu.

There are two basic Lock modes

- one mode where the frontpanel is unlocked simply by pressing the LOCK key once.
- another mode where you need to press LOCK and then dial in the "security code" followed by ENTER in order to unlock the function keys. The code is set via the Setup menu.

Timing function

A timing function can be set for both Lock modes allowing the front panel keys to be unlocked for either: 10, 30 or 60 seconds.

FRONT PANEL OPERATION

Auto Lock

Range: Off, 10 seconds, 30 seconds, 60 seconds

Lock Code

Range: 0000-9999

“0000” is “no lock code” and the front panel keys can be locked/unlocked simply by using the LOCK key.

The following section takes a look at the processing chain following the front panel layout from left to right. On the front panel this is called the “Schematic Section”

Digital In



The XO24 accepts digital Input at 44.1 or 48kHz. Per default the XO24 is set to analog Inputs.

To switch to the digital Inputs.

- Be sure that a valid digital Input signal is present in the DIGITAL IN connection.
- Press the DIGITAL IN key. Analog Inputs are muted and the key LED will flash until lock is achieved.
- To return to Analog Inputs - press once more.

Input Bypass A/B - Input Trim

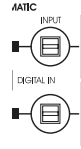

Signal from the two Inputs A and B will be passed to the Routing section if the LEDs in the two INPUT keys are lit.

- Press to activate/deactivate.

Input Trim

In Edit mode you have access to individual Input trim parameters on channels A and B.

Parametric EQ (Input EQ)

The Controller holds two parametric EQ sections. The first is located on the Input side of the Routing matrix. One for channel A and one for channel B.

Par EQ A, B	Type:	Gain	Freq:	Width/Slope:
Band 1	Lo Shelve		20 Hz – 20 kHz	6dB/Oct
	Hi Pass		20 Hz – 20 kHz	12dB/Oct
	Par EQ	±18 dB	20 Hz – 20 kHz	0,03 – 4 Oct
Band 2	Par EQ	±18 dB	20 Hz – 20 kHz	0,03 – 4 Oct
Band 3	Par EQ	±18 dB	20 Hz – 20 kHz	0,03 – 4 Oct
Band 4	Par EQ	±18 dB	20 Hz – 20 kHz	0,03 – 4 Oct
	Lo Pass		20 Hz – 20 kHz	12dB/Oct
	Hi Shelve		20 Hz – 20 kHz	6dB/Oct

FRONT PANEL OPERATION

Routing

Routing section -as illustrated on the Front panel

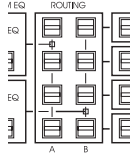

- alternative illustration of the Routing section

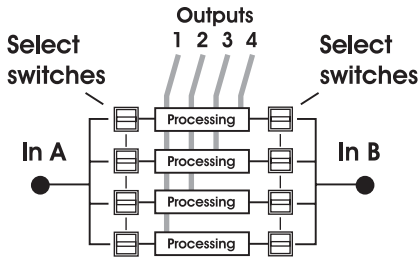

The Routing section is the “railway-station” in the signal chain. The signal present on Inputs A/B can via the 2x4 select switches be routed to none, any or all of the four Output channels.

From the Routing section out the four channels are individually processed with separate X-Over, EQ, Delay, Limiter and Output blocks.

Notice that the front panel layout is identical to the actual signal flow through the unit.

Example:

Input A distributed to Output 1 and 2
Input B distributed to Output 3 and 4

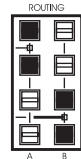

A typical example of a stereo setup with split in both sides.

More examples on pages 10 to 13.

X-Over

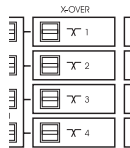

For optimal settings please refer to your speaker specifications.

The XO24 may hold presets that perfectly match your speaker configuration.

X-Over A,B:	Type:	Gain	Freq:	Width/Slope:
X-Over	Hi Pass Lo Pass	N/A	20 Hz – 20 kHz	1st order Butterworth 2. Butterworth 3. Butterworth 4. Bessel 2. Bessel 3. Bessel 4. Linkw.Riley 2. Linkw.Riley 4.

FRONT PANEL OPERATION

Parametric EQ (Speaker EQ)



EQ 1-4	Type:	Gain	Freq:	Width/Slope:
Band 1	Hi Pass	±18 dB	20 Hz – 20 kHz	2nd order
	or Par EQ	±18 dB	20 Hz – 20 kHz	0,03 – 4 Oct
Band 2	Par EQ	±18 dB	20 Hz – 20 kHz	0,03 – 4 Oct
Band 3	Par EQ	±18 dB	20 Hz – 20 kHz	0,03 – 4 Oct
Band 4	Lo Pass	±18 dB	20 Hz – 20 kHz	2nd order
	or Par EQ	±18 dB	20 Hz – 20 kHz	0,03 – 4 Oct

Delay Line

Delay for each speaker Line. Especially for compensating for speaker placement.

Range: 0 to 200ms

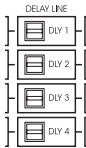

Ratio

Range: Off to Infinity

Sets the amount of attenuation.

Attack

Range: 1 to 100ms

The Attack time is the time it takes for the Limiter to reach the gain-reduction specified by the Ratio parameter.

Release

Range: 100ms to 7 sec.

Sets the time it will take for the Limiter to release the attenuation of the signal.

Limiter

A Limiter for each speaker line is available. Correctly set the Limiter will prevent peaks from damaging your speakers.

Threshold

Range: -40 to 0 dB

Sets the Threshold/activation point for the Limiter.

Output

Range: 6; 12; 18; 22dBu

It is important that the Controller Outputs are correctly matched to the Input range of your amplifier. Please refer to your amplifiers manual for correct settings.

APPENDIX - TECHNICAL SPECIFICATIONS

Analog Inputs

Connectors:	XLR
Impedance, Bal / Unbal:	21 kOhm / 13 kOhm
Max. / Min. Input Level @ 0 dBFS:	+24 dBu / 0 dBu
Sensitivity Range @ 12 dB headroom:	-12 dBu to +12 dBu
A to D Conversion:	24 bit, 128 x oversampling bitstream
A to D Delay:	0.70 ms / 0.65 ms @ 44.1 kHz / 48 kHz
Dynamic Range:	typ < -110 dB, 22 Hz to 22 kHz
THD:	typ < -110 dB @ 1 kHz, -1 dBFS
Frequency Response:	+0/-0.1 dB, 20 Hz to 20 kHz
Crosstalk:	typ < -100 dB, 20 Hz to 20 kHz

Analog Outputs

Connectors:	XLR
Impedance Bal / Unbal:	40 Ohm / 20 Ohm
Max. Output Level:	+20 dBu
D to A Conversion:	24 bit, 128 x oversampling bitstream
D to A Delay:	0.68 ms / 0.63 ms @ 44.1 kHz / 48 kHz
Dynamic Range:	typ < -110 dB typ, 22 Hz to 22 kHz
THD:	typ < -110 dB (0.0014 %) @ 1 kHz, +13 dBu
Frequency Response:	+0/-0.5 dB, 20 Hz to 20 kHz
Crosstalk:	typ < -100 dB, 20 Hz to 20 kHz

EMC Complies with:	EN 55103-1 and EN 55103-2
Safety Certified to:	FCC part 15, Class B, CISPR 22, Class B IEC 65, EN 60065, UL6500 and CSA E60065 CSA FILE #LR108093

Environment Operating Temperature:	32° F to 122° F (0° C to 50° C)
Storage temperature:	-22° F to 167° F (-30° C to 70° C)
Humidity:	Max. 90 % non-condensing

General

Finish:	Anodized aluminum front, plated and painted steel chassis
Display:	2 x 16 character LCD
Dimensions:	19" x 1.75" x 8" (483 x 44 x 105.6 mm)
Weight:	3.3 lbs (1.5 kg)
Mains Voltage:	100 to 240 VAC, 50 to 60 Hz (auto-select)
Power Consumption:	<15 W
Warranty Parts and labor:	1 year

Due to continuous development these specifications are subject to change without notice.

PRESET LIST

The XO24 factory presets are listed below. The presets are generic and should be perceived at excellent "starting points". To achieve optimal performance of your setup, the presets probably require some adjustment and fine-tuning according to the specifications of your speakers. Please refer to the documentation of your speakers.

Type	Name	Input button	PARAM INPUT	Routing	x-over	OUTPUT EQ	Delay	Limiter	Output		
#1	2 way	A-On B-On	A-On/ no EQ B-On/ no EQ	A - 1 L-Hi	HP - LR 4th order - 2.00 kHz	1-On/ no EQ	On/None	On/Lim Threshold 0dB	Off		
				A - 2 L-Low	LP - LR 4th order - 2.00 kHz	2-On/ no EQ	On/None	On/Lim Threshold 0dB	Off		
				B - 3 R-Hi	HP - LR 4th order - 2.00 kHz	3-On/ no EQ	On/None	On/Lim Threshold 0dB	Off		
				B - 4 R-Low	LP - LR 4th order - 2.00 kHz	4-On/ no EQ	On/None	On/Lim Threshold 0dB	Off		
#2	2 way	A-On B-On	A-On/ no EQ B-On/ no EQ	A - 1 L-Hi	HP - LR 4th order - 1.26 kHz	1-On/ no EQ	On/None	On/Lim Threshold 0dB	Off		
				A - 2 L-Low	LP - LR 4th order - 1.26 kHz	2-On/ no EQ	On/None	On/Lim Threshold 0dB	Off		
				B - 3 R-Hi	HP - LR 4th order - 1.26 kHz	3-On/ no EQ	On/None	On/Lim Threshold 0dB	Off		
				B - 4 R-Low	LP - LR 4th order - 1.26 kHz	4-On/ no EQ	On/None	On/Lim Threshold 0dB	Off		
#3	2 way	A-On B-On	A-On/ no EQ B-On/ no EQ	A - 1 L-Hi	HP - LR 4th order - 2.00 kHz	1-On/ no EQ	On/None	On/Lim Threshold 0dB	Off		
				A - 2 L-Low	LP - LR 4th order - 2.00 kHz	2-On/ no EQ	On/None	On/Lim Threshold 0dB	Off		
				B - 3 R-Hi	HP - LR 4th order - 2.00 kHz	3-On/ no EQ	On/None	On/Lim Threshold 0dB	Off		
				B - 4 R-Low	LP - LR 4th order - 2.00 kHz	4-On/ no EQ	On/None	On/Lim Threshold 0dB	Off		
#4	2 way	A-On B-On	A-On/ no EQ B-On/ no EQ	A - 1 L-Hi	HP - LR 4th order - 1.26 kHz	1-On/ no EQ	On/None	On/Lim Threshold 0dB	Off		
				A - 2 L-Low	LP - LR 4th order - 1.26 kHz	2-On/ no EQ	On/None	On/Lim Threshold 0dB	Off		
				B - 3 R-Hi	HP - LR 4th order - 1.26 kHz	3-On/ no EQ	On/None	On/Lim Threshold 0dB	Off		
				B - 4 R-Low	LP - LR 4th order - 1.26 kHz	4-On/ no EQ	On/None	On/Lim Threshold 0dB	Off		
#5	2 way	A-On B-On	A-On/ no EQ B-On/ no EQ	A - 1 L-HiPack	HP - LR 4th order - 100 Hz	1-On/ no EQ	On/None	On/Lim Threshold 0dB	Off		
				A - 2 L-Sub	LP - LR 4th order - 100 Hz	2-On/ no EQ	On/None	On/Lim Threshold 0dB	Off		
				B - 3 R-FullRange	HP - LR 4th order - 100 Hz	3-On/ no EQ	On/None	On/Lim Threshold 0dB	Off		
				B - 4 R-Sub	LP - LR 4th order - 100 Hz	4-On/ no EQ	On/None	On/Lim Threshold 0dB	Off		
#6	2 way	A-On B-On	A-On/ no EQ B-On/ no EQ	A - 1 L-HiPack	HP - LR 4th order - 199.5 Hz	1-On/ no EQ	On/None	On/Lim Threshold 0dB	Off		
				A - 2 L-Sub	LP - LR 4th order - 199.5 Hz	2-On/ no EQ	On/None	On/Lim Threshold 0dB	Off		
				B - 3 R-FullRange	HP - LR 4th order - 199.5 Hz	3-On/ no EQ	On/None	On/Lim Threshold 0dB	Off		
				B - 4 R-Sub	LP - LR 4th order - 199.5 Hz	4-On/ no EQ	On/None	On/Lim Threshold 0dB	Off		
#7	2 way	A-On B-On	A-On/ no EQ B-On	A - 1 L-FullRange	HP - LR 4th order - 20 Hz	1-On/ no EQ	On/None	On/Lim Threshold 0dB	Off		
				HiPack							
				A - 2 L-Sub	LP - LR 4th order - 100 Hz	2-On/ no EQ	On/None	On/Lim Threshold 0dB	Off		
				B - 3 R-FullRange	HP - LR 4th order - 20 Hz	3-On/ no EQ	On/None	On/Lim Threshold 0dB	Off		
#8	2 way	A-On B-On	A-On/ no EQ B-On/ no EQ	A - 1 L-FullRange	HP - LR 4th order - 20 Hz	1-On/ no EQ	On/None	On/Lim Threshold 0dB	Off		
				HiPack							
				A - 2 L-Sub	LP - LR 4th order - 199.5 Hz	2-On/ no EQ	On/None	On/Lim Threshold 0dB	Off		
				B - 3 R-FullRange	HP - LR 4th order - 20 Hz	3-On/ no EQ	On/None	On/Lim Threshold 0dB	Off		
#9	2 way	A-On B-On	A-On/ no EQ B-On/ no EQ	A - 1 L-FullRange	HP - LR 4th order - 199.5 Hz	1-On/ no EQ	On/None	On/Lim Threshold 0dB	Off		
				HiPack							
				B - 4 R-Sub	LP - LR 4th order - 199.5 Hz	4-On/ no EQ	On/None	On/Lim Threshold 0dB	Off		

PRESET LIST

Type	Name	Input button	PARAM EQ INPUT	Routing	x-over	OUTPUT EQ	Delay	Limiter	Output
#9	3Way	A-On B-On	A:On/ no EQ B:On/ no EQ	A - 1 High 2	HP LR 4th order - 1.2 kHz	1:On/ no EQ	On/None	On/Lim Threshold 0dB	Off
				A - 2 Mid 15	HP LR 4th order - 250Hz / LP LR 4th order - 1.2kHz	2:On/ no EQ	On/None	On/Lim Threshold 0dB	Off
				A - 3 Sub 18	LP LR 4th order - 250Hz	3:On/ no EQ	On/None	On/Lim Threshold 0dB	Off
				B - Fullrange	HP/LP - Off	4:Off no EQ	Off/None	On/Lim Threshold 0dB	Off
#10	4Way	A-On B-off	A:On/ no EQ B:On/ no EQ	A - 1 High	HP LR 2th order - 6 kHz	1:On/ no EQ	On/0ms	On/Lim Threshold 0dB	Off
				A - 2 Hi-Mid	HP LR 2th order - 1.2 kHz / LP LR 4th order - 6 kHz	2:On/ no EQ	On/0ms	On/Lim Threshold 0dB	Off
				A - 3 Lo-Mid	HP LR 2th order - 250 Hz / LP LR 4th order - 1.2 kHz	3:On/ no EQ	On/0ms	On/Lim Threshold 0dB	Off
				A - 4 Sub	LP LR 2th order - 250Hz	4:On/ no EQ	On/0ms	On/Lim Threshold 0dB	Off
#11	1way	A-On B-off	A:On/ no EQ B:On/ no EQ	A - 1 FullRange	HP/LP - Off	1:On/ no EQ	On/0ms	On/Lim Threshold 0dB	Off
				A - 2 FullRange	HP/LP - Off	2:On/ no EQ	On/0ms	On/Lim Threshold 0dB	Off
				A - 3 FullRange	HP/LP - Off	3:On/ no EQ	On/0ms	On/Lim Threshold 0dB	Off
				A - 4 FullRange	HP/LP - Off	4:On/ no EQ	On/0ms	On/Lim Threshold 0dB	Off
#12	TrueByPassSt	A-On B-On	A:off B:off	A - 1 FullRange	HP/LP - Off	1:Off/ no EQ	Off/0ms	Off/Lim Threshold 0dB	Off
				A - 2 FullRange	HP/LP - Off	2:Off/ no EQ	Off/0ms	Off/Lim Threshold 0dB	Off
				B - 3 FullRange	HP/LP - Off	3:Off/ no EQ	Off/0ms	Off/Lim Threshold 0dB	Off
				B - 4 FullRange	HP/LP - Off	4:Off/ no EQ	Off/0ms	Off/Lim Threshold 0dB	Off